



LISTA DE PRECIOS





Energía y productividad para un mundo mejor



BREAKERS DE RIEL SH200 1 POLO | 6KA | 400V

Imagen	Referencia	Tipo	Corriente Nominal (A)	Tensión Máxima Ub	Poder de Corte Icu (kA) 230 Vac	Precio USD
	2CDS211001R0024	SH201-C2	2	253 Vac	6	10.01
	2CDS211001R0044	SH201-C4	4	253 Vac	6	10.04
	2CDS211001R0064	SH201-C6	6	253 Vac	6	5.23
	2CDS211001R0104	SH201-C10	10	253 Vac	6	5.23
	2CDS211001R0164	SH201-C16	16	253 Vac	6	5.23
	2CDS211001R0204	SH201-C20	20	253 Vac	6	5.23
	2CDS211001R0254	SH201-C25	25	253 Vac	6	5.23
	2CDS211001R0324	SH201-C32	32	253 Vac	6	5.23
	2CDS211001R0404	SH201-C40	40	253 Vac	6	5.75
	2CDS211001R0504	SH201-C50	50	253 Vac	6	6.26
	2CDS211001R0634	SH201-C63	63	253 Vac	6	6.26

BREAKERS DE RIEL SH200 2 POLOS | 6KA | 400V

Imagen	Referencia	Tipo	Corriente Nominal (A)	Tensión Máxima Ub	Poder de Corte Icu (kA) 230 Vac	Precio USD
	2CDS212001R0024	SH202-C2	2	440 Vac	6	20.35
	2CDS212001R0044	SH202-C4	4	440 Vac	6	20.32
	2CDS212001R0064	SH202-C6	6	440 Vac	6	11.32
	2CDS212001R0104	SH202-C10	10	440 Vac	6	11.32
	2CDS212001R0164	SH202-C16	16	440 Vac	6	11.32
	2CDS212001R0204	SH202-C20	20	440 Vac	6	11.32
	2CDS212001R0254	SH202-C25	25	440 Vac	6	11.32
	2CDS212001R0324	SH202-C32	32	440 Vac	6	11.32
	2CDS212001R0404	SH202-C40	40	440 Vac	6	12.49
	2CDS212001R0504	SH202-C50	50	440 Vac	6	13.46
	2CDS212001R0634	SH202-C63	63	440 Vac	6	13.46

BREAKERS DE RIEL SH200 3 POLOS | 6KA | 400V

Imagen	Referencia	Tipo	Corriente Nominal (A)	Tensión Máxima Ub	Poder de Corte Icu (kA) 230 Vac	Precio USD
	2CDS213001R0024	SH203-C2	2	440 Vac	6	30.91
	2CDS213001R0044	SH203-C4	4	440 Vac	6	30.88
	2CDS213001R0064	SH203-C6	6	440 Vac	6	17.64
	2CDS213001R0104	SH203-C10	10	440 Vac	6	17.64
	2CDS213001R0164	SH203-C16	16	440 Vac	6	17.64
	2CDS213001R0204	SH203-C20	20	440 Vac	6	17.64
	2CDS213001R0254	SH203-C25	25	440 Vac	6	17.64
	2CDS213001R0324	SH203-C32	32	440 Vac	6	17.64
	2CDS213001R0404	SH203-C40	40	440 Vac	6	17.64
	2CDS213001R0504	SH203-C50	50	440 Vac	6	20.66
	2CDS213001R0634	SH203-C63	63	440 Vac	6	20.66

BREAKERS DE RIEL S200 1 POLO | 10KA | 400V

Imagen	Referencia	Tipo	Corriente Nominal (A)	Tensión Máxima Ub	Corriente última de ruptura Icu (kA)	Precio USD
	2CDS251001R0024	S201-C2	2	253 Vac/72 Vdc	10	13.17
	2CDS251001R0044	S201-C4	4	253 Vac/72 Vdc	10	14.42
	2CDS251001R0064	S201-C6	6	253 Vac/72 Vdc	10	13.17
	2CDS251001R0104	S201-C10	10	253 Vac/72 Vdc	10	12.09
	2CDS251001R0164	S201-C16	16	253 Vac/72 Vdc	10	12.09
	2CDS251001R0204	S201-C20	20	253 Vac/72 Vdc	10	12.09
	2CDS251001R0254	S201-C25	25	253 Vac/72 Vdc	10	12.09
	2CDS251001R0324	S201-C32	32	253 Vac/72 Vdc	10	12.09
	2CDS251001R0404	S201-C40	40	253 Vac/72 Vdc	10	15.28
	2CDS251001R0504	S201-C50	50	253 Vac/72 Vdc	10	15.48
	2CDS251001R0634	S201-C63	63	253 Vac/72 Vdc	10	15.48

BREAKERS DE RIEL S200 2 POLOS | 10KA | 400V

Imagen	Referencia	Tipo	Corriente Nominal (A)	Tensión Máxima Ub	Corriente última de ruptura Icu (kA)	Precio USD
	2CDS252001R0024	S202-C2	2	440 Vac/125 Vdc	10	29.46
	2CDS252001R0044	S202-C4	4	440 Vac/125 Vdc	10	29.46
	2CDS252001R0064	S202-C6	6	440 Vac/125 Vdc	10	29.46
	2CDS252001R0104	S202-C10	10	440 Vac/125 Vdc	10	22.42
	2CDS252001R0164	S202-C16	16	440 Vac/125 Vdc	10	22.42
	2CDS252001R0204	S202-C20	20	440 Vac/125 Vdc	10	22.42
	2CDS252001R0254	S202-C25	25	440 Vac/125 Vdc	10	22.42
	2CDS252001R0324	S202-C32	32	440 Vac/125 Vdc	10	22.42
	2CDS252001R0404	S202-C40	40	440 Vac/125 Vdc	10	31.36
	2CDS252001R0504	S202-C50	50	440 Vac/125 Vdc	10	31.36
	2CDS252001R0634	S202-C63	63	440 Vac/125 Vdc	10	31.36

BREAKERS DE RIEL S200 3 POLOS | 10KA | 400V

Imagen	Referencia	Tipo	Corriente Nominal (A)	Tensión Máxima Ub	Corriente última de ruptura Icu (kA)	Precio USD
	2CDS253001R0024	S203-C2	2	440 Vac	10	46.82
	2CDS253001R0044	S203-C4	4	440 Vac	10	46.82
	2CDS253001R0064	S203-C6	6	440 Vac	10	46.82
	2CDS253001R0104	S203-C10	10	440 Vac	10	31.83
	2CDS253001R0164	S203-C16	16	440 Vac	10	31.83
	2CDS253001R0204	S203-C20	20	440 Vac	10	31.83
	2CDS253001R0254	S203-C25	25	440 Vac	10	31.83
	2CDS253001R0324	S203-C32	32	440 Vac	10	31.83
	2CDS253001R0404	S203-C40	40	440 Vac	10	45.44
	2CDS253001R0504	S203-C50	50	440 Vac	10	45.44
	2CDS253001R0634	S203-C63	63	440 Vac	10	45.44

ACCESORIO PARA BREAKERS DE RIEL S200

Imagen	Referencia	Descripción	Tipo	Precio USD
	2CDS200912R0001	Contacto Auxiliar: Indicación de la posición de los contactos del dispositivo. SPDT 1NA+1NC	S 2C-H6R	18.29

BREAKERS DE CAJA MOLDEADA FORMULA | 1 POLO | 415 VAC - 125 VDC - 25 KA A 240V

Imagen	Referencia	Tipo	Corriente Nominal (A)	Corriente última de ruptura Icu (kA)	Protección Cortocircuito I3 (A)	Precio USD
	1SDA066485R1	A1C 125 TMF 15-400 1p F F TMF	15	18	400	62.39
	1SDA066686R1	A1N 125 TMF 20-400 1p F F TMF	20	20	400	64.33

BREAKERS DE CAJA MOLDEADA FORMULA | 2 POLOS | 550 VAC - 250 VDC - 50KA A 240 VAC - 25KA A 440 VAC

Imagen	Referencia	Tipo	Corriente Nominal (A)	Corriente última de ruptura Icu (kA)	Protección Cortocircuito I3 (A)	Precio USD
	1SDA068789R1	A1N 125 TMF 15-400 2p F F TMF	15	50	400	75.06
	1SDA066497R1	A1N 125 TMF 20-400 2p F F TMF	20	50	400	75.06
	1SDA066498R1	A1N 125 TMF 25-400 2p F F TMF	25	50	400	75.06
	1SDA066499R1	A1N 125 TMF 30-400 2p F F TMF	30	50	400	75.06
	1SDA066500R1	A1N 125 TMF 40-400 2p F F TMF	40	50	400	75.06
	1SDA066501R1	A1N 125 TMF 50-500 2p F F TMF	50	50	500	75.06
	1SDA066502R1	A1N 125 TMF 60-600 2p F F TMF	60	50	600	75.06
	1SDA066503R1	A1N 125 TMF 70-700 2p F F TMF	70	50	700	88.15
	1SDA066504R1	A1N 125 TMF 80-800 2p F F TMF	80	50	800	88.15
	1SDA066506R1	A1N 125 TMF 100-1000 2p F F TMF	100	50	1000	88.15
	1SDA066507R1	A1N 125 TMF 125-1250 2p F F TMF	125	50	1250	157.44
	1SDA068778R1	A2N 250 TMF 150-1500 2p F F TMF	150	50	1500	180.75
	1SDA066543R1	A2N 250 TMF 160-1600 2p F F TMF	160	50	1600	180.75
	1SDA066544R1	A2N 250 TMF 175-1750 2p F F TMF	175	50	1750	194.39
	1SDA066545R1	A2N 250 TMF 200-2000 2p F F TMF	200	50	2000	194.39
	1SDA066546R1	A2N 250 TMF 225-2250 2p F F TMF	225	50	2250	194.39
1SDA066547R1	A2N 250 TMF 250-2500 2p F F TMF	250	50	2500	202.16	

BREAKERS DE CAJA MOLDEADA FORMULA | 3 POLOS | 550 VAC - 250 VDC - 25KA A 240 VAC - 15KA A 440 VAC

Imagen	Referencia	Tipo	Corriente Nominal (A)	Corriente última de ruptura Icu (kA)	Protección Cortocircuito I3 (A)	Precio USD
	1SDA066697R1	A1B 125 TMF 15-400 3p F F TMF	15	25	400	89.95
	1SDA066698R1	A1B 125 TMF 20-400 3p F F TMF	20	25	400	89.95
	1SDA066700R1	A1B 125 TMF 30-400 3p F F TMF	30	25	400	89.95
	1SDA066701R1	A1B 125 TMF 40-400 3p F F TMF	40	25	400	89.95
	1SDA066702R1	A1B 125 TMF 50-500 3p F F TMF	50	25	500	89.95
	1SDA066703R1	A1B 125 TMF 60-600 3p F F TMF	60	25	600	89.95
	1SDA066704R1	A1B 125 TMF 70-700 3p F F TMF	70	25	700	98.20
	1SDA066705R1	A1B 125 TMF 80-800 3p F F TMF	80	25	800	98.20
	1SDA066707R1	A1B 125 TMF 100-1000 3p F F TMF	100	25	1000	98.20
	1SDA066708R1	A1B 125 TMF 125-1250 3p F F TMF	125	25	1250	134.58
	1SDA068779R1	A2B 250 TMF 150-1500 3p F F TMF	150	25	1500	188.46
	1SDA066549R1	A2B 250 TMF 160-1600 3p F F TMF	160	25	1600	188.46
	1SDA066550R1	A2B 250 TMF 175-1750 3p F F TMF	175	25	1750	246.28
	1SDA066777R*	A2B 250 TMF 175-1750 3p F F TMF	175	25	1750	246.28
	1SDA066784R1	A2N 250 TMF 200-2000 3p F F TMF	200	85	2000	252.03
	1SDA066785R1	A2N 250 TMF 225-2250 3p F F TMF	225	85	2250	252.03
	1SDA066786R1	A2N 250 TMF 250-2500 3p F F TMF	250	85	2500	262.19
	1SDA066560R1	A3N 400 TMF 320-3200 3p F F TMF	320	85	3200	676.31
	1SDA066561R1	A3N 400 TMF 400-4000 3p F F TMF	400	85	4000	676.31

BLOQUES CONTACTOS AUXILIARES BREAKERS FORMULA

Imagen	Referencia	Tipo	Modelo de Interruptor	Precio USD
	1SDA066151R1	AUX-C 1Q+1SY 250 Vac/dc	A1 2p	41.13
	1SDA054910R1	AUX-C 1Q+ 1SY 250 Vac/dc	A3	55.14
	1SDA066150R1	AUX-C 2Q+1SY 250 Vac/dc	A1-A2 3p-4p	39.24
	1SDA066152R1	AUX-C 2Q+1SY 250 Vac/dc	A2 2p	41.13

BOBINA MÍNIMA DE TENSIÓN PARA BREAKERS FORMULA

Imagen	Referencia	Tipo	Modelo de Interruptor	Precio USD
	1SDA066145R1	UVR-C 110-127 Vac-110-125 Vdc	A1-A2	69.97
	1SDA066146R1	UVR-C 220-240 Vac-220-250 Vdc	A1-A2	69.97

ACCESORIO FIJACIÓN EN RIEL DIN PARA BREAKERS FORMULA

Imagen	Referencia	Tipo	Modelo de Interruptor	Precio USD
	1SDA066180R1	Brida para guía DIN 1p-2p-3p-4p	A1-A2	7.09

MANDO GIRATORIO PARA BREAKERS FORMULA

Imagen	Referencia	Descripción	Precio USD
	1SDA066158R1	RHE, A1-A2 para puerta ajustable en profundidad	74.09

TERMINALES JAULA PARA BREAKERS FORMULA

Imagen	Referencia	Tipo	Modelo de Interruptor	Precio USD
	1SDA066235R1	KIT FC CuAl A1 60A 2pcs 25 mm ²	A1	10.48
	1SDA066236R1	KIT FC CuAl A1 60A 3pcs 25 mm ²	A1	15.42
	1SDA066241R1	KIT FC CuAl A1 125A 2pcs 50 mm ²	A1	10.48
	1SDA066242R1	KIT FC CuAl A1 125A 3pcs 50 mm ²	A1	15.42
	1SDA066253R1	KIT FC CuAl A2 250A 2pcs 150 mm ²	A2	18.09
	1SDA066254R1	KIT FC CuAl A2 250A 3pcs 185 mm ²	A2	28.87
	1SDA055024R1	KIT FC CuAl A3 400A 3pcs 300 mm ²	A3	99.88

BREAKERS CAJA MOLDEADA TMAX XT 3 POLOS

Imagen	Referencia	Tipo	Corriente Nominal (A)	Protección Sobrecarga (A)	Corriente última de ruptura Icu (kA)		Precio USD
					220 Vac	440 Vac	
	1SDA066799R1	XT1B 160 TMD 16-450 3p F F	16	11,2-16	25	15	95.19
	1SDA066800R1	XT1B 160 TMD 20-450 3p F F	20	14-20	25	15	95.19
	1SDA066802R1	XT1B 160 TMD 32-450 3p F F	32	22,4-32	25	15	95.19
	1SDA066803R1	XT1B 160 TMD 40-450 3p F F	40	28-40	25	15	95.19
	1SDA066804R1	XT1B 160 TMD 50-500 3p F F	50	35-50	25	15	95.19
	1SDA066805R1	XT1B 160 TMD 63-630 3p F F	63	44,1-63	25	15	95.19
	1SDA066806R1	XT1B 160 TMD 80-800 3p F F	80	56-80	25	15	104.88
	1SDA066807R1	XT1B 160 TMD 100-1000 3p F F	100	70-100	25	15	104.88
	1SDA066808R1	XT1B 160 TMD 125-1250 3p F F	125	87,5-125	25	15	150.71
	1SDA066809R1	XT1B 160 TMD 160-1600 3p F F	160	112-160	25	15	205.75
	1SDA068058R1	XT3N 250 TMD 200-2000 3p F F	200	140-200	50	25	340.55
	1SDA068059R1	XT3N 250 TMD 250-2500 3p F F	250	175-250	50	25	404.93
	1SDA100344R1	XT5N 400 TMA 320-3200 3p F F	320	224-320	70	36	743.82
	1SDA100345R1	XT5N 400 TMA 400-4000 3p F F	400	280-400	70	36	752.86
	1SDA100346R1	XT5N 630 TMA 500-5000 3p F F	500	350-500	70	36	1,086.20
	1SDA100347R1	XT5N 630 TMA 630-6300 3p F F	630	441-630	70	36	1,169.41
	1SDA100718R1	XT6N 800 TMA 800-8000 3p F F	800	560-800	70	30	2,160.20
	1SDA100353R1*	XT5N 400 Ekip Dip LS/I In=320A 3p F F	320	128-320	70	36	797.61
	1SDA100355R1	XT5N 600 Ekip Dip LS/I In=630A 3p F F	630	441-630	70	36	1,203.82
	1SDX158788R1	XT6N 1000 Ekip Dip LS/I In=1000 3p F EF	1000	400-1000	70	30	3,163.05
1SDA100832R1	XT7S 1250 Ekip Dip LSI In=1250A 3p F F	1250	500-1250	85	50	3,631.05	
1SDA100833R1	XT7S 1600 Ekip Dip LSI In=1600A 3p F F	1600	640-1600	85	50	4,301.15	
1SDA101368R1	XT7SM 1250 Ekip Dip LS/I In=1250A 3p F F	1250	500-1250	85	50	3,288.63	
1SDA101369R1	XT7SM 1600 Ekip Dip LS/I In=1600A 3p F F	1600	640-1600	85	50	4,402.47	



Conozca más de TMAX XT

ACCESORIOS PARA BREAKERS TMAX XT

Imagen	Referencia	Descripción	Tipo	Modelo de Interruptor	Precio USD
	1SDA066431R1	Bloque Contacto Auxiliar	AUX-C 1Q+1SY 250 Vac/dc F/P	XT1-XT2-XT3-XT4-XT5-XT6	33.68
	1SDA073750R1	Bloque Contacto Auxiliar	AUX-C 4Q 400 Vac	XT7-XT7M,E1.2	226.61
	1SDA066316R1	Bobina Apertura	SOR 110...127 Vac-110...125 Vdc	XT1-XT2-XT3-XT4	40.20
	1SDA066317R1	Bobina Apertura	SOR 220...240 Vac-220...250 Vdc	XT1-XT2-XT3-XT4	40.20
	1SDA104926R1	Bobina Mínima Tensión	YO 110/240 Vac/dc	XT5-XT6	72.84
	1SDA066391R1	Bobina Mínima Tensión	UVR 110-127 Vac-110-125 Vdc	XT1-XT2-XT3-XT4	55.72
	1SDA066392R1	Bobina Mínima Tensión	UVR 220-240 Vac-220-250 Vdc	XT1-XT2-XT3-XT4	55.72
	1SDA104943R1	Bobina Mínima Tensión	UVR 110-127 Vac/dc	XT5-XT6	86.14
	1SDA104944R1	Bobina Mínima Tensión	YU 220-240 Vac/dc	XT5-XT6	86.14
	1SDA073881R1	Cables enclavamiento	A-HR	XT7-X7M, E1.2...E6.2	83.10
	1SDA105093R1	Cierre con llave	MOL-M	XT5...XT6	48.93
	1SDA066459R1	Mando Motor	MOD XT1-XT3 110...125 Vac/dc	XT1-XT3	259.14
	1SDA066460R1	Mando Motor	MOD XT1-XT3 220...250 Vac/dc	XT1-XT3	259.14
	1SDA104883R1	Mando Motor	MOE XT5 110...125 Vac/dc	XT5	798.74
	1SDA104885R1	Mando Motor	MOE XT5 220...250 Vac/dc	XT5	798.74
	1SDA104895R1	Mando Motor	MOE XT6 220...250 Vac/dc	XT6	1,535.40
	1SDA104922R1	Motor Carga Resortes	M XT7M 220-250 Vac/dc	XT7M	1,230.44
	1SDA073894R1	Placa enclavamiento	Horizontal Tipo A	XT7-XT7M,E1.2	217.29
	1SDA066639R1	Enclavamiento	MIR-P placa para XT1 F	XT1	44.03
	1SDA066643R1	Enclavamiento	MIR-P placa para XT3 F	XT3	44.03
	1SDA105117R1	Enclavamiento	MIR-H Bastidor horizontal	XT5	158.32
	1SDA105122R1	Enclavamiento	MIR-P placa para XT5 F	XT5	33.01
	1SDA105118R1	Enclavamiento	MIR-H Bastidor horizontal	XT6	366.28
	1SDA105126R1	Enclavamiento	MIR-P placa para XT6 F	XT6	73.24
	1SDA066637R1	Enclavamiento	MIR-HR bastidor metálico horizontal XT1..XT4	XT1-XT2-XT3-XT4	229.88
	1SDA066479R1	Mando Giratorio completo	RHE para XT1-XT3	XT1-XT3	66.38
	1SDA104843R1	Mando Giratorio completo	RHE_B para XT5	XT5	159.27
	1SDA104853R1	Mando Giratorio completo	RHE_B para XT6	XT6	358.19
	1SDA104863R1	Mando Giratorio completo	RHE_B para XT7	XT7	389.34
	1SDA066907R1	Terminal Jaula	KIT FC Cu XT1 6pcs, terminales para cables de cobre	XT1	15.73
	1SDA066913R1	Terminal Jaula	KIT FC Cu XT3 3pcs, terminales para cables de cobre	XT3	15.73
	1SDA104748R1	Terminal Jaula	Cual XT5 3pcs 2x500mcm, 2x240 mm ²	XT5	121.33
	1SDA104752R1	Terminal Jaula	Cual XT6 3pcs 3x350mcm, 3x185 mm ²	XT6	205.02
	1SDA104758R1	Terminal Jaula	Cual XT7-XT7M 3pcs 4x500mcm, 4x240 mm ²	XT7-XT7M	227.86
	1SDA104754R1	Terminal Externo	FC Cual XT6 3pz 4x70, 150 mm ²	XT6	116.09

BREAKERS DE BASTIDOR ABIERTO EMAX 2

Imagen	Referencia	Tipo	Corriente Nominal (A)	Protección sobrecarga	Corriente última de ruptura Icu (kA)	Precio USD
	1SDA071061R1	E2.2N 2500A Ekip Dip LI	2500	1000-2500	66kA	Consultar precio
	1SDA071141R1	E4.2N 3200A, Ekip Dip LI 3P F HR	3200	1280-3200	66kA	Consultar precio
	1SDA071191R1	E4.2N 4000A, Ekip Dip LI FHR	4000	1600-4000	66kA	Consultar precio

ACCESORIOS PARA BREAKERS EMAX2

Imagen	Referencia	Descripción	Tipo	Tensión de Alimentación	Para uso con interruptor	Precio USD
	1SDA073674R1	Bobina apertura	YO Relé de apertura	220-240 Vac/dc	XT7-XT7M, E1.2, E2.2, E4.2, E6.2	232.61
	1SDA073687R1	Bobina cierre	YO Relé de cierre	220-240 Vac/dc	XT7-XT7M, E1.2, E2.2, E4.2, E6.2	232.61
	1SDA073700R1	Bobina mínima tensión	YU Relé de mínima tensión	220-240 Vac/dc	XT7-XT7M, E1.2, E2.2, E4.2, E6.2	259.24
	1SDA073885R1	Cables enclavamiento	A - vertical	-	XT7-XT7M, E1.2, E2.2, E4.2, E6.2	86.72
	1SDA074150R1	Ekip Com. Modbus	RS-485	-	E1.2..E6.2	1,098.60
	1SDA074172R1	Ekip Supply	Suministro de energía	110-240Vac/dc	E1.2..E6.2	692.56
	1SDA073725R1	Motor cargas resortes	M Motorreductor	220-250 Vac/dc	E2.2, E4.2, E6.2	1,222.05
	1SDA073724R1	Motor cargas resortes	M Motorreductor	100-130 Vac/dc	E2.2, E4.2, E6.2	1,222.05
	1SDA073889R1	Palanca enclavamiento	Accesorio para enclavamiento. Para montar en la parte móvil del interruptor extraíble o en el lateral del interruptor automático fijo ABCD		E2.2	143.56
	1SDA073895R1	Soporte enclavamiento	Accesorio para enclavamiento. Tipo A / B / D		E2.2, E4.2, E6.2	172.11



Conozca más sobre EMAX2

NOMENCLATURA PARA CODIFICACIÓN DE CONTACTORES TIPO AF

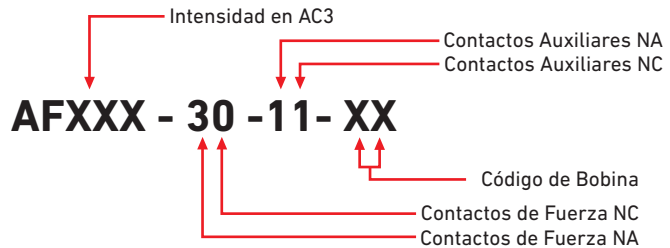

TIPO DE CONTACTOR	CÓDIGO BOBINA
AF09...AF370	
24...60 Vac/dc	11
48...130 Vac/dc	12
100...250 Vac/dc	13
250...500 Vac/dc	14
AF400...AF1250	
24...60 Vac/dc	68
48...130 Vac/dc	69
100...250 Vac/dc	70
250...500 Vac/ac	71
AF1350...AF2850	
100...250 Vac/dc	70



CONTACTORES 3 POLOS TIPO AF

Imagen	Referencia	Tipo	Corriente Nominal		Potencia de trabajo AC3 (kW)		Voltaje	Contactos auxiliares	Precio USD
			AC3	AC1	440 Vac	220-240 Vac			
	1SBL137001R1110	AF09-30-10-11	9	25	4	2.2	24...60 Vac/dc	1NA	37.26
	1SBL137001R1310	AF09-30-10-13	9	25	4	2.2	100...250 Vac/dc	1NA	35.75
	1SBL137001R1410	AF09-30-10-14	9	25	4	2.2	250...500 Vac/dc	1NA	37.26
	1SBL157001R1110	AF12-30-10-11	12	28	5.5	3	24...60 Vac/dc	1NA	47.77
	1SBL157001R1310	AF12-30-10-13	12	28	5.5	3	100...250 Vac/dc	1NA	46.45
	1SBL157001R1410	AF12-30-10-14	12	28	5.5	3	250...500 Vac/dc	1NA	47.77
	1SBL177001R1110	AF16-30-10-11	18	30	9	4	24...60 Vac/dc	1NA	58.03
	1SBL177001R1310	AF16-30-10-13	18	30	9	4	100...250 Vac/dc	1NA	58.03
	1SBL177001R1410	AF16-30-10-14	18	30	9	4	250...500 Vac/dc	1NA	58.03
	1SBL237001R1100	AF26-30-00-11	26	45	15	6.5	24...60 Vac/dc	-	78.33
	1SBL237001R1300	AF26-30-00-13	26	45	15	6.5	100...250 Vac/dc	-	78.33
	1SBL237001R1400	AF26-30-00-14	26	45	15	6.5	250...500 Vac/dc	-	78.33
	1SBL277001R1100	AF30-30-00-11	32	50	18.5	9	24...60 Vac/dc	-	105.57
	1SBL277001R1300	AF30-30-00-13	32	50	18.5	9	100...250 Vac/dc	-	105.57
	1SBL277001R1400	AF30-30-00-14	32	50	18.5	9	250...500 Vac/dc	-	106.23
	1SBL297001R1100	AF38-30-00-11	38	50	22	11	24...60 Vac/dc	-	127.24
	1SBL297001R1300	AF38-30-00-13	38	50	22	11	100...250 Vac/dc	-	127.24
	1SBL297001R1400	AF38-30-00-14	38	50	22	11	250...500 Vac/dc	-	129.00
	1SBL347001R1100	AF40-30-00-11	40	70	22	11	24...60 Vac/dc	-	212.34
	1SBL347001R1300	AF40-30-00-13	40	70	22	11	100...250 Vac/dc	-	141.49
	1SBL347001R1400	AF40-30-00-14	40	70	22	11	250...500 Vac/dc	-	141.49
	1SBL367001R1111	AF52-30-11-11	53	80	30	15	24...60 Vac/dc	1NA+1NC	267.48
	1SBL367001R1311	AF52-30-11-13	53	80	30	15	100...250 Vac/dc	1NA+1NC	192.34
	1SBL367001R1411	AF52-30-11-14	53	80	30	15	250...500 Vac/dc	1NA+1NC	192.34
	1SBL387001R1111	AF65-30-11-11	65	105	37	18.5	24...60 Vac/dc	1NA+1NC	306.63
	1SBL387001R1311	AF65-30-11-13	65	105	37	18.5	100...250 Vac/dc	1NA+1NC	252.70
	1SBL387001R1411	AF65-30-11-14	65	105	37	18.5	250...500 Vac/dc	1NA+1NC	252.70
	1SBL397001R1111	AF80-30-11-11	80	125	45	22	24...60 Vac/dc	1NA+1NC	379.29
	1SBL397001R1311	AF80-30-11-13	80	125	45	22	100...250 Vac/dc	1NA+1NC	315.19
	1SBL397001R1411	AF80-30-11-14	80	125	55	22	250...500 Vac/dc	1NA+1NC	325.25
1SBL407001R1111	AF96-30-11-11	96	130	55	25	24...60 Vac/dc	1NA+1NC	394.01	
1SBL407001R1311	AF96-30-11-13	96	130	55	25	100...250 Vac/dc	1NA+1NC	360.68	
1SBL407001R1411	AF96-30-11-14	96	130	55	25	250...500 Vac/dc	1NA+1NC	374.00	
1SFL427001R1311	AF116-30-11-13	116	160	75	30	100...250 Vac/dc	1NA+1NC	442.84	
1SFL427001R1411	AF116-30-11-14	116	160	75	30	250...500 Vac/dc	1NA+1NC	442.84	
1SFL447001R1311	AF140-30-11-13	140	200	90	37	100...250 Vac/dc	1NA+1NC	543.06	
1SFL467001R1311	AF146-30-11-13	146	225	90	45	100...250 Vac/dc	1NA+1NC	593.33	
1SFL467001R1411	AF146-30-11-14	146	225	90	45	250...500 Vac/dc	1NA+1NC	627.66	
1SFL487002R1311	AF190-30-11-13	190	275	110	55	100...250 Vac/dc	1NA+1NC	659.43	
1SFL527002R1311	AF205-30-11-13	205	350	132	55	100...250 Vac/dc	1NA+1NC	769.73	
1SFL547002R1311	AF265-30-11-13	265	400	160	75	100...250 Vac/dc	1NA+1NC	909.89	
1SFL587002R1311	AF305-30-11-13	305	500	160	90	100...250 Vac/dc	1NA+1NC	973.40	
1SFL577001R7011	AF400-30-11-70	400	600	220	110	100...250 Vac/dc	1NA+1NC	1,628.88	
1SFL597001R7011	AF460-30-11-70	460	700	250	132	100...250 Vac/dc	1NA+1NC	2,238.71	
1SFL617001R7011	AF580-30-11-70	580	800	355	160	100...250 Vac/dc	1NA+1NC	2,958.69	

ACCESORIOS PARA CONTACTORES

Imagen	Referencia	Tipo	Descripción	Contactos auxiliares	Precio USD
	1SBN010110R1001	CA4-01	Contacto auxiliar 1NC para contactor AF9 hasta AF96, montaje frontal	1NC	4.60
	1SBN010110R1010	CA4-10	Contacto auxiliar 1NA+1NC para contactor AF9 hasta AF96, montaje frontal	1NA	4.60
	1SFN010720R1011	CA4-18	Contacto auxiliar 1NA+1NC para contactor AF400-28,50 montaje lateral	1NA+1NC	38.31
	1SFN010820R3311	CAL 19-11B	Contacto auxiliar 1NA+1NC para contactor AF116 hasta AF370, montaje lateral	1NA+1NC	31.01
	1SBN010120R1011	CAL4-11	Contacto auxiliar 1NA+1NC para contactor AF9 hasta AF96, montaje lateral	1NA+1NC	12.25
	Referencia	Tipo	Descripción	Modelo	Precio USD
	1SBN030111R1000	VEM4	Enclavamiento electro-mecánico VEM4 de AF9-AF38	Electro Mecánico	21.78
	1SFN030300R1000	VM19	Enclavamiento para contactores AF116-AF370	Mecánico	68.62
	1SBN030105T1000	VM4	Enclavamiento para contactores AF9 a AF38	Mecánico	10.06
	1SBN033405T1000	VM96-4	Enclavamiento para contactores AF40 a AF96	Mecánico	12.34
	Referencia	Tipo	Descripción	Tipo de Guardamotor	Precio USD
	1SBN081306T1000	BEA16-4	Accesorio de conexión para unión contactores AF09 ... AF16 con guardamotores	MS116-132	9.53
	1SBN082306T2000	BEA38-4	Accesorio de conexión para contactores AF26... AF38 con guardamotores	MS116-132	11.24
	1SBN083406R1000	BEA65-4	Accesorio de conexión para contactores AF40...AF65 con guardamotores	MS165	27.26

RELÉS TÉRMICOS

Imagen	Referencia	Tipo	Rango de Protección	Para uso con contactor	Precio USD
	1SAZ721201R1023	TF42-1.0	0.74 - 1.00A	AF09 - AF38	50.77
	1SAZ721201R1025	TF42-1.3	1.00 - 1.30A	AF09 - AF38	50.77
	1SAZ721201R1028	TF42-1.7	1.30 - 1.70A	AF09 - AF38	50.77
	1SAZ721201R1031	TF42-2.3	1.70 - 2.30A	AF09 - AF38	50.77
	1SAZ721201R1033	TF42-3.1	2.30 - 3.10A	AF09 - AF38	50.77
	1SAZ721201R1035	TF42-4.2	3.10 - 4.20A	AF09 - AF38	50.77
	1SAZ721201R1038	TF42-5.7	4.20 - 5.70A	AF09 - AF38	50.77
	1SAZ721201R1040	TF42-7.6	5.70 - 7.60A	AF09 - AF38	50.77
	1SAZ721201R1043	TF42-10	7.60 - 10.0A	AF09 - AF38	50.77
	1SAZ721201R1045	TF42-13	10.0 - 13.0A	AF09 - AF38	56.17
	1SAZ721201R1047	TF42-16	13.0 - 16.0A	AF09 - AF38	56.17
	1SAZ721201R1049	TF42-20	16.0 - 20.0A	AF09 - AF38	56.17
	1SAZ721201R1051	TF42-24	20.0 - 24.0A	AF09 - AF38	71.48
	1SAZ721201R1052	TF42-29	24.0 - 29.0A	AF09 - AF38	81.98
	1SAZ721201R1053	TF42-35	29.0 - 35.0A	AF09 - AF38	84.30
1SAZ721201R1055	TF42-38	35.0 - 38.0A	AF09 - AF38	84.30	
	1SAZ811201R1001	TF 65-28	22,0 - 28,0 A	AF40 - AF65	83.69
	1SAZ811201R1002	TF65-33	25,0 - 33,0 A	AF40 - AF65	89.54
	1SAZ811201R1003	TF 65-40	30,0 - 40,0 A	AF40 - AF65	96.50
	1SAZ811201R1004	TF65-47	36,0 - 47,0 A	AF40 - AF65	98.81
	1SAZ811201R1005	TF65-53	44,0 - 53,0 A	AF40 - AF65	112.80
	1SAZ811201R1006	TF65-60	50,0 - 60,0 A	AF40 - AF65	116.26
	1SAZ811201R1007	TF65-67	57,0 - 67,0 A	AF40 - AF65	118.61
	1SAZ911201R1002	TF 96-60	48,0 - 60,0 A	AF80 - AF96	122.11
	1SAZ911201R1003	TF 96-68	57,0 - 68,0 A	AF80 - AF96	127.88
	1SAZ911201R1004	TF96-78	65,0 - 78,0 A	AF80 - AF96	149.93
	1SAZ911201R1005	TF96-87	75,0 - 87,0 A	AF80 - AF96	162.78
	1SAZ911201R1006	TF96-96	84,0 - 96,0 A	AF80 - AF96	174.41
	1SAZ431201R1002	TF140DU-110	80,0 - 110,0 A	AF116 - AF140	191.81
1SAZ431201R1003	TF140DU-135	100,0 - 135,0 A	AF116 - AF140	203.44	
1SAZ431201R1004	TF140DU-142	110,0 - 142,0 A	AF116 - AF140	215.07	

ACCESORIOS PARA RELÉS TÉRMICOS

Imagen	Referencia	Descripción	Precio USD
	1SAZ701902R0001	Base montaje independiente modelo DB42 para uso hasta TF42	23.24
	1SAZ801901R1001	Base montaje independiente DB65 uso hasta TF65	41.78
	1SAZ901901R1001	Base montaje independiente DB96 uso hasta TF96	116.83

GUARDAMOTORES MS116

Imagen	Referencia	Tipo	Rango de ajuste	Capacidad de cortocircuito ruptura Icu		Precio USD
				230V (kA)	440V (kA)	
	1SAM250000R1003	MS116-0.4	0,25 - 0.4	100	100	50.01
	1SAM250000R1004	MS116-0.63	0,40 - 0.63	100	100	50.01
	1SAM250000R1005	MS116-1.0	0,63 - 1.0	100	100	59.70
	1SAM250000R1006	MS116-1.6	1.0 - 1.6	100	100	59.70
	1SAM250000R1007	MS116-2.5	1.6 - 2.5	75	30	59.70
	1SAM250000R1008	MS116-4.0	2.5 - 4.0	75	18	59.70
	1SAM250000R1009	MS116-6.3	4.0 - 6.3	75	18	59.70
	1SAM250000R1012	MS116-12	8 - 12A	50	15	70.28
	1SAM250000R1013	MS116-20	16 - 20A	16	15	81.88
	1SAM250000R1014	MS116-25	20 - 25A	16	15	93.09
	1SAM250000R1015	MS116-32	25 - 32A	16	15	116.48

GUARDAMOTORES MS132

Imagen	Referencia	Tipo	Rango de ajuste	Capacidad de cortocircuito ruptura Icu		Precio USD
				230V (kA)	440V (kA)	
	1SAM350000R1007	MS132-2.5	1,6 - 2,5	100	30	82.32
	1SAM350000R1009	MS132-6.3	4,0 - 6,3	100	30	82.32
	1SAM350000R1010	MS132-10	6,3 - 10	100	30	97.45
	1SAM350000R1012	MS132-12	8.0 - 12	100	30	97.45
	1SAM350000R1011	MS132-16	10 - 16	100	30	97.45
	1SAM350000R1013	MS132-20	16 - 20	100	30	105.43
	1SAM350000R1014	MS132-25	20 - 25	50	30	119.18
	1SAM350000R1015	MS132-32	25 - 32	50	30	150.16

GUARDAMOTORES MS165

Imagen	Referencia	Tipo	Rango de ajuste	Capacidad de cortocircuito ruptura Icu		Precio USD
				230V (kA)	440V (kA)	
	1SAM451000R1015	MS165-42	30 - 42	50	50	282.63
	1SAM451000R1016	MS165-54	40 - 54	50	45	317.98
	1SAM451000R1017	MS165-65	52 - 65	50	45	330.08
	1SAM451000R1018	MS165-73	62 - 73	30	18	350.55
	1SAM451000R1019	MS165-80	70 - 80	30	18	370.47

ACCESORIOS PARA GUARDAMOTORES

Imagen	Referencia	Tipo	Descripción	Precio USD
	1SAM201902R1001	HK1-11 Aux.-contact	Contacto auxiliar 1NA+1NC lateral derecho MS116/132/165	10.56
	1SAM201901R1001	HKF1-11 Aux.-contact	Contacto auxiliar 1NA+1NC frontal MS116/132/165	10.19
	1SAM201903R1001	SK1-11 Signal contact	Contacto de falla 1NA+1NC lateral derecho MS116/132/165	16.60

RELAYS DE INTERFACE Y BASES

Imagen	Referencia	Tipo	Voltaje de control	Contactos	Corriente contactos (A)	Precio USD
	1SVR405600R4000	CR-P012DC1	12 Vdc	1 conmutado	16	5.66
	1SVR405600R1000	CR-P024DC1	24 Vdc	1 conmutado	16	5.66
	1SVR405600R2000	CR-P120AC1	120 Vac	1 conmutado	16	8.34
	1SVR405600R3000	CR-P230AC1	230 Vac	1 conmutado	16	11.10
	1SVR405650R1000	CR-PSS	Base para relé enchufable, 1 contacto			7.05
	1SVR405659R0000	CR-PH	Clip de retención plástico para relés modelo CR-P			0.51

RELAYS Y BASES 8 PINES PLANOS

Imagen	Referencia	Tipo	Voltaje de control	Contactos	Corriente contactos (A)	Precio USD
	1SVR405611R4000	CR-M012DC2	12 Vdc	2 conmutados	12	13.09
	1SVR405611R1000	CR-M024DC2	24 Vac	2 conmutados	12	12.06
	1SVR405611R0000	CR-M024AC2	24 Vac	2 conmutados	12	13.83
	1SVR405611R7000	CR-M110AC2	110 Vac	2 conmutados	12	13.09
	1SVR405611R2000	CR-M120AC2	120 Vac	2 conmutados	12	13.09
	1SVR405611R3000	CR-M230AC2	220 Vac	2 conmutados	12	14.14
	1SVR405651R1100	CR-M2LS	Base para relé enchufable, 2 contactos			7.08
	1SVR405659R1100	CR-MH1	Soporte metálico para fijación de relé			0,65

RELAYS Y BASES 11 PINES PLANOS

Imagen	Referencia	Tipo	Voltaje de control	Contactos	Corriente contactos (A)	Precio USD
	1SVR405612R4000	CR-M012DC3	12 Vdc	3 conmutados	10	12.29
	1SVR405612R1000	CR-M024DC3	24 Vdc	3 conmutados	10	13.89
	1SVR405612R8200	CR-M125AC3	125 Vdc	3 conmutados	10	14.54
	1SVR405612R0000	CR-M024AC3	24 Vac	3 conmutados	10	14.34
	1SVR405612R2000	CR-M120AC3	120 Vac	3 conmutados	10	13.49
	1SVR405612R3000	CR-M230AC3	230 Vac	3 conmutados	10	14,54
	1SVR405651R2100	CR-M3LS	Base para relé enchufable, 3 contactos			8,02

RELAYS Y BASES 14 PINES PLANOS

Imagen	Referencia	Tipo	Voltaje de control	Contactos	Corriente contactos (A)	Precio USD
	1SVR405613R4000	CR-M012DC4	12 Vdc	4 conmutados	6	12.95
	1SVR405613R1000	CR-M024DC4	24 Vdc	4 conmutados	6	14.26
	1SVR405613R0000	CR-M024AC4	24 Vdc	4 conmutados	6	14,82
	1SVR405613R8200	CR-M125DC4	125 Vdc	4 conmutados	6	14.71
	1SVR405613R7000	CR-M110AC4	110 Vac	4 conmutados	6	14.26
	1SVR405613R3000	CR-M230AC4	220 Vac	4 conmutados	6	14,71
	1SVR405651R3100	CR-M4LS	Base para relé enchufable, 4 contactos			8,25

RELAYS Y BASES 8 PINES REDONDOS

Imagen	Referencia	Tipo	Voltaje de control	Contactos	Corriente contactos (A)	Precio USD
	1SVR405621R4000	CR-U012DC2	12 Vdc	2 conmutados	10	17.70
	1SVR405621R1000	CR-U024DC2	24 Vdc	2 conmutados	10	17.99
	1SVR405621R0000	CR-U240AC2	24 Vac	2 conmutados	10	20.10
	1SVR405621R7000	CR-U110AC2	110 Vac	2 conmutados	10	18.73
	1SVR405621R3000	CR-U230AC2	230 Vac	2 conmutados	10	19.10
	1SVR405670R0000	CR-U2S	Base para relé enchufable, 2 contactos			9.67

RELAYS Y BASES 11 PINES REDONDOS

Imagen	Referencia	Tipo	Voltaje de control	Contactos	Corriente contactos (A)	Precio USD	
	1SVR405622R4000	CR-U012DC3	12 Vdc	3 conmutados	10	19.84	
	1SVR405622R1000	CR-U024DC3	24 Vdc	3 conmutados	10	19.84	
	1SVR405622R0000	CR-U024AC3	24 Vac	3 conmutados	10	20.83	
	1SVR405622R7000	CR-U110AC3	110 Vac	3 conmutados	10	19.38	
	1SVR405622R3000	CR-U230AC3	220 Vac	3 conmutados	10	19.92	
	1SVR405660R0000	CR-U3S	Base para relé enchufable, 3 contactos				8.22

PRODUCTOS ELECTRÓNICOS

Imagen	Referencia	Tipo	Descripción	Voltaje	Precio USD
	1SVR730850R0200	CM-ENS.21S	Detector nivel alto o bajo de líquido	24-240 Vac/dc	150.09
	1SVR402902R0000	CM-HE	Electrodo sin cable	-	33.41
	2CSM222531R1000	DW1	Reloj digital semanal 1 Channel	230 Vac 16A C/BAT	210.88
	2CSM222521R1000	DW2	Reloj digital semanal 2 Channel	230 Vac 16A C/BAT	297.40
	1SVR730831R1400	CM-ESS.2S	Supervisor Monofásico	3-600 Vac	295.93
	1SVR730794R1300	CM-PVS.31S	Supervisor 3F Completo	160-300 Vac	291.25
	1SVR730794R3300	CM-PVS.41S	Supervisor 3F Completo	300-500 Vac	291.25
	1SVR550029R8100	CT-MFE	Timer Multifunción 1c/o, 0.05s-100h	24-240 Vac/dc	111.31
	1SVR550107R2100	CT-ERE	Timer on-delay 3-300S 1 c/o	24 Vac/dc 240 Vac	59.23
	1SVR508211R0100	CT-SDC.22	Timer Y-D	24 Vac/dc 240 Vac	87.51

LUCES PILOTO MONOBLOCK

Imagen	Referencia	Tipo	Descripción	Tensión nominal	Vida útil hora	Protección Frontal	Precio USD
	1SFA619403R5023	CL2-502Y	Piloto amarilla	24 Vac/dc	> 50,000	IP 66	13.53
	1SFA619403R5133	CL2-513Y	Piloto amarilla	130 Vac	> 50,000	IP 66	13.53
	1SFA619403R5153	CL2-515Y	Piloto amarilla	130 Vdc	> 50,000	IP 66	13.53
	1SFA619403R5233	CL2-523Y	Piloto amarilla	230 Vac	> 50,000	IP 66	13.53
	1SFA619403R5134	CL2-513L	Piloto azul	130 Vac	> 50,000	IP 66	13.53
	1SFA619403R5234	CL2-523L	Piloto azul	230 Vac	> 50,000	IP 66	13.53
	1SFA619403R5138	CL2-513C	Piloto blanca	130 Vac	> 50,000	IP 66	13.53
	1SFA619403R5238	CL2-523C	Piloto blanca	230 Vac	> 50,000	IP 66	13.53
	1SFA619403R5021	CL2-502R	Piloto rojo	24 Vac/dc	> 50,000	IP 66	13.53
	1SFA619403R5131	CL2-513R	Piloto rojo	130 Vac	> 50,000	IP 66	13.53
	1SFA619403R5151	CL2-515R	Piloto rojo	130 Vdc	> 50,000	IP 66	13.53
	1SFA619403R5231	CL2-523R	Piloto rojo	230 Vac	> 50,000	IP 66	13.53
	1SFA619403R5022	CL2-502G	Piloto verde	24 Vac/dc	> 50,000	IP 66	13.53
	1SFA619403R5132	CL2-513G	Piloto verde	130 Vac	> 50,000	IP 66	13.53
	1SFA619403R5152	CL2-515G	Piloto verde	130 Vdc	> 50,000	IP 66	13.53
	1SFA619403R5232	CL2-523G	Piloto verde	230 Vac	> 50,000	IP 66	13.53

PULSADORES MONOBLOCK

Imagen	Referencia	Tipo	Descripción	Precio USD
	1SFA619100R1012	CP1-10G-10	Pulsador rasante verde, 1NO Momentáneo, IP66	9.08
	1SFA619100R1041	CP1-10R-01	Pulsador rasante rojo, 1NC Momentáneo, IP66	9.08
	1SFA619100R1112	CP1-11G-10	Pulsador luminoso 22 mm verde 1NO 24 Vac/dc, IP66	15.93
	1SFA619100R1312	CP1-13G-10	Pulsador luminoso 22 mm verde 1NO 220 Vac/dc, IP66	15.93
	1SFA619100R1141	CP1-11R-01	Pulsador luminoso 22 mm rojo 1NC 24 Vac/dc, IP66	15.93
	1SFA619100R1341	CP1-13R-01	Pulsador luminoso 22 mm rojo 1NC 220 Vac/dc, IP66	15.93
	1SFA619100R1113	CP1-11Y-10	Pulsador luminoso 22 mm amarillo 1NO 24 Vac/dc, IP66	15.93
	1SFA619100R1313	CP1-13Y-10	Pulsador luminoso 22 mm amarillo 1NO 220 Vac/dc, IP66	15.93
	1SFA619500R1071	CE3T-10R-11	Pulsador emergencia rojo giro 1NA+1NC, Ø 30 mm, IP66	19.31

SELECTORES MONOBLOQUES

Imagen	Referencia	Tipo	Descripción	Precio USD
	1SFA619201R1016	C2SS2-10B-10	Selector 2 posiciones corto negro retorno manual 1NA IP66	16.34
	1SFA619210R1026	C3SS1-10B-20	Selector 3 posiciones corto, negro, 2NA, retorno manual IP66	20.71

ELEMENTOS DE MANDO MODULARES

Imagen	Referencia	Tipo	Descripción	Precio USD
	1SFA611610R1001	MCB-10	Bloque de contactos 1 NA	6.46
	1SFA611610R1010	MCB-01	Bloque de contactos 1 NC	6.46
	1SFA611130R1106	MPD1-11B	Cabezal de pulsador doble. Verde (arriba) Rojo (abajo)	19.73
	1SFA611523R1001	MPET4-10R	Cabezal de parada de emergencia. 40 mm, desenganche por giro	16.13
	1SFA611100R1101	MP1-11R	Cabezal pulsador 22mm - Luminoso rojo	11.30
	1SFA611100R1102	MP1-11G	Cabezal pulsador 22mm - Luminoso verde	11.30
	1SFA611100R1001	MP1-10R	Cabezal pulsador 22mm - rasante rojo	5.84
	1SFA611100R1002	MP1-10G	Cabezal pulsador 22mm - rasante verde	5.84
	1SFA611200R1006	M2SS1-10B	Cabezal para selector de 2 posiciones retorno manual	15.22
	1SFA611210R1006	M3SS1-10B	Cabezal para selector de 3 posiciones retorno manual	15.22
	1SFA611605R1200	MCBH-001	Portabloques + Portalámpara	8.28
	1SFA611605R1100	MCBH-00	Portabloques sin contactos	1.85
	1SFA611410R3106	MT-310B	Potenciómetro 10KOHMIOS CHROME-METAL IP66	100.60

ACCESORIOS PARA ELEMENTOS DE MANDO

Imagen	Referencia	Tipo	Descripción	Precio USD
	1SFA616920R8029	KA1-8029	Adaptador 30 mm, uso pulsadores, selectores, luces piloto de 22 mm, plástico negro	10.27



Conozca más sobre elementos de mando



Productos de bajo voltaje y sistemas

ANALIZADORES Y MEDIDORES

Imagen	Referencia	Descripción	Precio USD
	1SYG207591R4051	Medidor digital M1M12 / Voltaje Auxiliar 80-300 Vac/dc	167.97
	1SYG207581R4051	Medidor digital M1M12 MODBUS TRMS 40-300 Vac	184.14
	2CSG251151R4051	Analizador digital M4M20 / Voltaje Auxiliar 48-240 Vac/dc Bluetooth	681.09
	2CSG251141R4051	Analizador digital M4M20, MODBUS RTU / Voltaje Auxiliar 48-240 Vac/dc Bluetooth	756.35
	2CSG204471R4051	Analizador digital M4M20, ETHERNET / Voltaje Auxiliar 48-240 Vac/dc Bluetooth	993.26
	2CSG251131R4051	Analizador digital M4M20, PROFIBUS / Voltaje Auxiliar 48-240 Vac/dc Bluetooth	1,031.84

INTERRUPTORES DE LEVAS

Imagen	Referencia	Descripción	Corriente (A)	Precio USD
	1SCA104902R1001	3 polos OT40F3 - S/MANETA-EJE	40A	40.13
	1SCA105332R1001	3 polos OT63F3 - S/MANETA-EJE	63A	55.67
	1SCA105798R1001	3 polos OT80F3 - S/MANETA-EJE	80A	76.50
	1SCA105033R1001	3 polos OT125F3 - S/MANETA-EJE	125A	129.33
	1SCA120514R1001	3 polos OT160E03P - C/MANETA-EJE	160A	272.72

TRANSFERENCIAS MANUALES

Imagen	Referencia	Características	Amperaje	Precio USD
	1SCA105338R1001	3 Polos OT63F3C - S/MANETA-EJE	63 A	139.93
	1SCA105402R1001	3 Polos OT80F3C - S/MANETA-EJE	80 A	166.72
	1SCA105037R1001	3 Polos OT125F3C - S/MANETA-EJE	125 A	319.49
	1SCA022772R6510	3 Polos OT160E03CP - C/MANETA-EJE	160 A	564.93
	1SCA022771R3450	3 Polos OT250E03CP - C/MANETA-EJE	250 A	812.43
	1SCA022772R6780	3 Polos OT315E03CP - C/MANETA-EJE	315 A	956.58
	1SCA022771R8500	3 Polos OT400E03CP - C/MANETA-EJE	400 A	1,027.48

ACCESORIOS PARRA INTERRUPTORES DE LEVAS Y TRANSFERENCIAS

Imagen	Referencia	Descripción	Precio USD
	1SCA022353R4970	Bloque de contacto auxiliar 1NO 16A, 690V, OT-OTM	8.74
	1SCA022456R7410	Bloque de contacto auxiliar 1NC 16A, 690V OTM	10.25
	1SCA108043R1001	Eje 105 mm, Diámetro 6 mm, Interruptores OT16...125F y OT160G	7.75
	1SCA101654R1001	Eje 120 mm, Diámetro 6 mm para OT16...125F y OT160G	6.22
	1SCA109089R1001	Maneta negra con interlock interruptor OT16...125F	5.54
	1SCA105210R1001	Maneta negra con interlock interruptor OT16...125F, Tipo selector	12.39
	1SCA105220R1001	Maneta tipo selector transferencias OT16...125F	15.89

TRANSFERENCIAS MOTRICES

Imagen	Referencia	Características	Amperaje	Precio USD
	1SCA022845R8610	3 Polos 690V motor: 230 Vac	160 A	1,678.92
	1SCA022847R1210	3 Polos 690V motor: 230 Vac	315 A	2,182.03
	1SCA022847R1630	3 Polos 690V motor: 230 Vac	400 A	2,513.58
	1SCA103567R1001	3 Polos 690V motor: 230 Vac	630 A	3,672.12
	1SCA103570R1001	3 Polos 690V motor: 230 Vac	800 A	3,803.16
	1SCA112676R1001	3 Polos 690V motor: 230 Vac	1250 A	5,452.95
	1SCA112678R1001	3 Polos 690V motor: 230 Vac	1600 A	6,463.68

ARRANCADORES SUAVES PSR | GAMA COMPACTA

Imagen	Referencia	Tipo	Potencia del motor HP		Corriente nominal del motor (A)	Precio USD
			440 Vac	230 Vac		
	1SFA896107R7000	PSR 16-600-70	10	5	16	298.09
	1SFA896108R7000	PSR 25-600-70	15	7,5	25	309.80
	1SFA896109R7000	PSR 30-600-70	20	10	30	376.36
	1SFA896110R7000	PSR 37-600-70	25	10	37	526.91
	1SFA896111R7000	PSR 45-600-70	30	15	45	596.21
	1SFA896112R7000	PSR60-600-70	40	20	60	701.40
	1SFA896113R7000	PSR72-600-70	50	30	72	872.86
	1SFA896114R7000	PSR85-600-70	60	30	85	997.45
	1SFA896115R7000	PSR105-600-70	75	40	105	1,044.22

ARRANCADORES SUAVES PSE | GAMA EFICIENTE

Imagen	Referencia	Tipo	Potencia del motor HP		Máxima corriente nominal del motor (A)		Precio USD
			440 Vac	230 Vac	Carga Normal	Carga Pesada	
	1SFA897102R7000	PSE25-600-70	15	7,5	25	18	1,038.80
	1SFA897103R7000	PSE30-600-70	20	10	30	25	1,102.25
	1SFA897104R7000	PSE37-600-70	25	10	37	30	1,143.74
	1SFA897105R7000	PSE45-600-70	30	15	45	37	1,239.73
	1SFA897106R7000	PSE60-600-70	40	20	60	45	1,396.70
	1SFA897107R7000	PSE72-600-70	50	25	72	60	1,605.73
	1SFA897108R7000	PSE85-600-70	60	30	85	72	1,846.43
	1SFA897109R7000	PSE105-600-70	75	40	105	85	1,826.69
	1SFA897110R7000	PSE142-600-70	100	50	142	106	2,347.90
	1SFA897111R7000	PSE170-600-70	120	60	170	143	2,855.51
	1SFA897112R7001	PSE210-600-70-1	150	80	210	171	3,412.28
	1SFA897113R7001	PSE250-600-70-1	180	100	250	210	3,603.72
	1SFA897114R7001	PSE300-600-70-1	215	120	300	250	4,388.76
	1SFA897115R7001	PSE370-600-70-1	270	150	370	300	5,798.92

ARRANCADORES SUAVES PSTX | GAMA AVANZADA

Imagen	Referencia	Tipo	Potencia del motor HP		Máxima corriente nominal del motor (A)		Precio USD
			440 Vac	230 Vac	Carga Normal	Carga Pesada	
	1SFA898106R7000	PSTX60-600-70	40	20	60	45	2,191.65
	1SFA898107R7000	PSTX72-600-70	50	25	72	60	2,520.24
	1SFA898108R7000	PSTX85-600-70	60	30	85	72	2,897.92
	1SFA898109R7000	PSTX105-600-70	75	40	105	85	3,288.75
	1SFA898110R7000	PSTX142-600-70	100	50	142	105	3,136.04
	1SFA898111R7000	PSTX170-600-70	120	60	170	142	3,523.20
	1SFA898112R7000	PSTX210-600-70	150	80	210	175	4,015.21
	1SFA898113R7000	PSTX250-600-70	180	100	250	210	4,579.94
	1SFA898114R7000	PSTX300-600-70	215	120	300	250	5,164.32
	1SFA898115R7000	PSTX370-600-70	270	150	370	300	6,823.60
	1SFA898116R7000	PSTX470-600-70	340	180	470	370	7,958.78
	1SFA898117R7000	PSTX570-600-70	425	220	570	470	8,356.11



ARRANCADORES SUAVES PSR, PSE, PSTX

Descarga de manual de arrancadores suaves en pdf.

TABLEROS PLÁSTICOS GEMINI CON PUERTA OPACA | IP66 1K10

Imagen	Referencia	Descripción	Precio USD
	1SL0221A00*	Tablero plástico 40x33.5x21 cm - tamaño 1 con plafón	241.98
	1SL0222A00*	Tablero plástico 55x46x26 cm - tamaño 2 con plafón	325.98
	1SL0223A00*	Tablero plástico 70x46x26 cm - tamaño 3 con plafón	385.37
	1SL0224A00*	Tablero plástico 70x59x26 cm - tamaño 4 con plafón	516.19
	1SL0225A00*	Tablero plástico 85.5x59x36 cm - tamaño 5 con plafón	674.25
	1SL0226A00*	Tablero plástico 100.5x84x36 cm - tamaño 6 con plafón	988.43



Alertas y avisos
Reciba alarmas en tiempo real para anticiparse a problemas en su instalación.



Control automático
Respuesta inmediata a los eventos seleccionados, sin intervenciones manuales.



Solución escalable, integrable en sistemas Cloud.

UNIDAD DE CONTROL INSITE SCU100 Y ACCESORIOS

	Referencia	Descripción	Precio USD
	2CCG000242R0001	Insite Pro M Compact Unidad de Control SCU100	Consultar precio
	2CCG000243R0001	Cable plano 5 m INS105	Consultar precio
	2CCG000244R0001	Juegos de conectores INS135 (35 pzas.)	Consultar precio
	2CCG000245R0001	Módulo en entradas digitales DM11	Consultar precio
	2CCG000247R0001	Módulo de entradas/salidas digitales DM10	Consultar precio
	2CCG000246R0001	Módulo de salida digital DM00	Consultar precio
	2CCA880222R0001	Sensor núcleo abierto 20A, CMS-122CA	Consultar precio
	2CCA880221R0001	Sensor núcleo abierto 40A, CMS-121CA	Consultar precio
	2CCA880220R0001	Sensor núcleo abierto 80A, CMS-120CA	Consultar precio

SISTEMA DE MEDICIÓN DE CORRIENTE

Imagen	Referencia	Descripción	Precio USD
	2CCA880331R0001	Cable plano 5M -4C*28AWG	Consultar precio
	2CCA880145R0001	Juego conector CMS-820, 35PZ	Consultar precio

VARIADORES ACS310 220V

Imagen	Referencia	Modelo	Potencia del motor (trifásico 220V)	Bastidor	Corriente (A)	Precio USD
	3AUA0000039192*	ACS310-03E-05A2-2	1HP/0.75KW	R1	5,2	484.37
	3AUA0000038843	ACS310-01E-04A7-2	1HP/0.75KW	R1	4,7	357.34
	3AUA0000039218	ACS310-03E-08A3-2	2HP/1.5KW	R1	8,3	614.27
	3AUA0000038845	ACS310-01E-07A5-2	2HP/1.5KW	R2	7,5	504.99
	3AUA0000039234	ACS310-03E-10A8-2	3HP/2.2KW	R2	10,8	696.96
	3AUA0000039071	ACS310-01E-09A8-2	3HP/2.2KW	R2	9,8	553.72
	3AUA0000039621	ACS310-03E-19A4-2	5HP/4kW	R2	19,4	930.26
	3AUA0000039622	ACS310-03E-26A8-2	7,5HP/5.5kW	R3	26,8	1,163.56
	3AUA0000039623	ACS310-03E-34A1-2	10HP/7.5kW	R4	34,1	1,494.33
	3AUA0000039624	ACS310-03E-50A8-2	15HP/11kW	R4	50,8	1,950.61

VARIADORES ACS355 220V

Imagen	Referencia	Modelo	Potencia del motor (trifásico 220V)	Bastidor	Corriente (A)	Precio USD
	3AUA0000058175*	ACS355-03E-07A5-2	2HP/1.5KW	R1	7,50	610.86
	3AUA0000058176	ACS355-03E-09A8-2	3HP/2.2KW	R2	9,80	776.69
	3AUA0000058178	ACS355-03E-17A6-2	5HP/4KW	R2	17,60	1,039.54
	3AUA0000058179	ACS355-03E-24A4-2	7.5HP/5.5KW	R3	24,40	1,355.53
	3AUA0000058180	ACS355-03E-31A0-2	10HP/7.5KW	R4	31,00	1,802.95
	3AUA0000058181	ACS355-03E-46A2-2	15HP/11KW	R4	46,20	2,349.29

VARIADORES ACS580 220V

Imagen	Referencia	Modelo	Potencia del motor (trifásico 220V)	Bastidor	Corriente (A)	Precio USD
	3AXD50000417414	ACS580-01-047A-2	15HP/11KW	R3	46,7	3,504.16
	3AXD50000417421	ACS580-01-060A-2	20HP/15KW	R3	60	4,304.38
	3AXD50000417438	ACS580-01-089A-2	30HP/22KW	R5	89	5,639.98
	3AXD50000417445	ACS580-01-115A-2	40HP/30KW	R5	115	6,595.41

VARIADORES ACS880 220V

Imagen	Referencia	Modelo	Potencia del motor (trifásico 220V)	Bastidor	Corriente (A)	Precio USD
	3AUA0000137239*	ACS880-01-075A-2	25HP/18.5KW	R5	75	4,637.79
	3AUA0000137240*	ACS880-01-087A-2	30HP/22KW	R5	87	5,422.38
	3AUA0000137241*	ACS880-01-115A-2	40HP/30KW	R6	115	7,038.00
	3AUA0000137242*	ACS880-01-145A-2	50HP/37KW	R6	145	8,386.37
	3AUA0000137254*	ACS880-01-206A-2	75HP/55KW	R7	206	12,064.48

VARIADORES ACS310 440V

Imagen	Referencia	Modelo	Potencia del motor (trifásico 440V)	Bastidor	Corriente (A)	Precio USD
	3AUA0000039627	ACS310-03E-02A6-4	1HP/0.75KW	R1	2,6	544.87
	3AUA0000039629	ACS310-03E-04A5-4	2HP/1.5KW	R1	4,5	733.87
	3AUA0000039630	ACS310-03E-06A2-4	3HP/2,2kW	R1	6,2	791.46
	3AUA0000039631	ACS310-03E-08A0-4	4HP/3KW	R1	8,0	899.25
	3AUA0000039632	ACS310-03E-09A7-4	5HP/4kW	R1	9,7	1,018.86
	3AUA0000039633	ACS310-03E-13A8-4	7,5HP/5.5kW	R3	13,8	1,286.12
	3AUA0000039634	ACS310-03E-17A2-4	10HP/7.5kW	R3	17,2	1,599.17
	3AUA0000039635	ACS310-03E-25A4-4	15HP/11kW	R3	25,4	2,045.10
	3AUA0000039636	ACS310-03E-034A-4	20HP/15kW	R4	34,1	2,451.17
	3AUA0000039638	ACS310-03E-48A4-4	30HP/22kW	R4	48,4	3,449.37

VARIADORES ACS480 440V

Imagen	Referencia	Modelo	Potencia del motor (trifásico 440V)	Bastidor	Corriente (A)	Precio USD
	3AXD50000047765	ACS480-04-02A7-4	1.0HP/0.75KW	R1	2,6	666.37
	3AXD50000047766	ACS480-04-03A4-4	1.5HP/1.1KW	R1	3,3	770.31
	3AXD50000047767	ACS480-04-04A1-4	2HP/1.5KW	R1	4	898.46
	3AXD50000047768	ACS480-04-05A7-4	3HP/2.2KW	R1	5,6	971.08
	3AXD50000047769	ACS480-04-07A3-4	4HP/3KW	R1	7,2	1,100.65
	3AXD50000047770	ACS480-04-09A5-4	5HP/4KW	R1	9,4	1,248.74
	3AXD50000047791	ACS480-04-12A7-4	7.5HP/5.5KW	R2	12,6	1,549.17
	3AXD50000047792	ACS480-04-018A-4	10HP/7.5KW	R3	17	1,846.77
	3AXD50000047793	ACS480-04-026A-4	15HP/11 KW	R3	25	2,299.56
	3AXD50000199068	ACS480-04-033A-4	20HP/15 KW	R4	32	2,997.26
	3AXD50000199075	ACS480-04-039A-4	25HP/18.5 KW	R4	38	3,497.04
	3AXD50000199099	ACS480-04-050A-4	30HP/22KW	R4	50	4,278.75

VARIADORES ACS580 440V

Imagen	Referencia	Modelo	Potencia del motor (trifásico 440V)	Bastidor	Corriente (A)	Precio USD
	3AXD50000038959	ACS580-01-018A-4	10HP/7.5KW	R2	17	2,204.16
	3AXD50000038960	ACS580-01-026A-4	15HP/11KW	R2	25	2,641.29
	3AXD50000038961	ACS580-01-033A-4	20HP/15KW	R3	32	3,304.82
	3AXD50000038963	ACS580-01-046A-4	30HP/22KW	R3	45	4,557.83
	3AUA0000080499	ACS580-01-073A-4	50HP/37KW	R4	73	6,330.56
	3AUA0000080503	ACS580-01-106A-4	75HP/55KW	R5	106	8,566.05
	3AUA0000080504	ACS580-01-145A-4	100HP/75KW	R6	145	9,829.03

VARIADORES ACS880 440V

Imagen	Referencia	Modelo	Potencia del motor (trifásico 440V)	Bastidor	Corriente (A)	Precio USD
	3AUA0000090435	ACS880-01-021A-5	15HP/11KW	R2	21	3,369.64
	3AUA0000153357	ACS880-01-034A-5	25HP/18.5KW	R3	34	4,524.34
	3AUA0000090439*	ACS880-01-052A-5	40HP/30KW	R4	52	4,737.14
	3AUA0000082214	ACS880-01-065A-5	50HP/37KW	R5	65	7,353.54
	3AUA0000090440	ACS880-01-077A-5	60HP/45KW	R5	77	8,878.88
	3AUA0000090441	ACS880-01-096A-5	75HP/55 KW	R6	96	9,977.49
	3AUA0000090442	ACS880-01-124A-5	100HP/75 KW	R6	124	10,965.34
	3AUA0000090443	ACS880-01-156A-5	120HP/90 KW	R7	156	13,946.62
	3AUA0000090444	ACS880-01-180A-5	150HP/110KW	R7	180	16,210.28
	3AUA0000090445	ACS880-01-240A-5	180HP/132 KW	R8	240	17,881.81
	3AUA0000090446	ACS880-01-260A-5	215HP/160 KW	R8	260	22,158.09
	3AUA0000082215	ACS880-01-361A-5	270HP/200KW	R9	361	25,167.42
	3AUA0000090447	ACS880-01-414A-5	335HP/250KW	R9	414	35,506.69



Catálogo de Variadores ACS880



Manual en línea ACS580 (sobre pared)



Manual en línea ACS580 (Para tablero)



Manual en línea ACS580 (Para tablero)

ACCESORIOS PARA VARIADORES

Imagen	Referencia	Tipo	Descripción	Precio USD
	3AUA0000108878	DPMP-01	Montaje panel en puerta	508.88
	3AUA0000089109	FENA-21	Adaptador protocolo comunicaciones drives 2 puertos Ethernet	940.85
	3AXD500000259	ACS-AP-W	Panel bluetooth para ACS480-580-880	360.48
	3AUA0000064884	ACS-AP-S	Panel de control estándar para ACS380-480-580	246.80
	3AUA0000088311	ACS-AP-I	Panel de control asistente para ACS480-580-880	360.48
	3AXD50000028828	ACS-BP-S	Panel de ccontrol básico para ACS380-480-580	113.67
	64739000	ACS-CP-C	Panel de control básico para ACS310-355	107.69
	64691473	ACS-CP-A	Panel de control avanzado (asistente) para ACS310-355	373.94

SMART SENSOR Y ACCESORIOS

Imagen	Referencia	Descripción	Precio USD
	3AXD50000823772	Smart Sensor G2 STD con accesorios montaje	622.38
	3AFP9127707	Licencia de Smart Sensor por 1 año	291.22
	3AXD50000823772	Smart Sensor STD C/ACC. montaje + Licencia 1 años	913.61

TRANSFORMADORES 1F (MONOFÁSICOS) SECOS | 120-240/12-24V | ABIERTOS

Imagen	Referencia	Potencia	Voltaje de entrada	Voltaje de salida	Medidas (Profundidad x Ancho x Alto)	Precio USD
	9T58K2876	150VA	120-240	12-24	11,7x9,7x8,3 cm	184.05
	9T58K2878	250VA	120-240	12-24	13x9,7x8,3 cm	231.98
	9T58K2879	300VA	120-240	12-24	13x9,7x8,3 cm	254.27



Diagrama 1



Diagrama 7

TRANSFORMADORES 1F (MONOFÁSICOS) SECOS | 240-480/12-24V | ABIERTOS

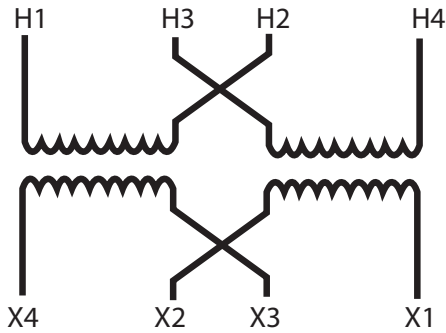
Imagen	Referencia	Potencia	Voltaje de entrada	Voltaje de salida	Medidas (Profundidad x Ancho x Alto)	Precio USD
	9T58K4132	100VA	240-480	12-24	10,5x9,7x8,3 cm	214.10
	9T58K4133	150VA	240-480	12-24	11,7x9,7x8,3 cm	227.34
	9T58K3024	250VA	240-480	12-24	13x9,7x8,3 cm	231.98

TRANSFORMADORES 1F (MONOFÁSICOS) SECOS | 240-480/120-240V | ABIERTOS

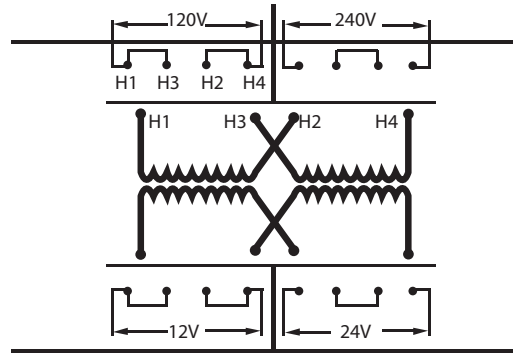
Imagen	Referencia	Potencia	Voltaje de entrada	Voltaje de salida	Medidas (Profundidad x Ancho x Alto)	Precio USD
	9T58K2804	100VA	240-480	120-240	10,5x9,7x8,3 cm	208.79
	9T58K2807	250VA	240-480	120-240	13x9,7x8,3 cm	233.47
	9T58K2808	300VA	240-480	120-240	13x9,7x8,3 cm	243.11
	9T58K2810	500VA	240-480	120-240	14,6x11,6x9,9 cm	332.54
	9T58K2811	750VA	240-480	120-240	14,8x13,5x11,6 cm	397.43
	9T58K2812	1000VA	240-480	120-240	16,7x13,5x11,6 cm	509.16
	9T58K2813	1500VA	240-480	120-240	16x17,3x14,8 cm	667.60
	9T58K2814	2000VA	240-480	120-240	17,9x17,3x14,8 cm	850.75
	9T58K2815	3000VA	240-480	120-240	22,4x17,3x14,8 cm	1,117.79

TRANSFORMADORES ENCAPSULADOS 3R

Descripción del producto

Los transformadores incrementadores – reductores son pequeños, monofásicos, tipo seco para distribución, diseñados como transformadores de aislamiento. Ellos tienen doble voltaje primario y doble voltaje secundario. Estos transformadores pueden ser conectados en una amplia gama de combinaciones de voltaje.

Su uso más común es para incrementar o reducir el voltaje en una pequeña cantidad, usualmente del 5% al 27%.

Cumplen con lo requerido por el NEC Artículo 210-9, Excepción 1, cuando se conectan como autotransformadores. Los transformadores incrementadores – reductores de ABB proveen un método económico y conveniente para aumentar o reducir el voltaje, usualmente en no más de $\pm 20\%$ tanto para circuitos monofásicos como trifásicos. Esta solución es compacta, relativamente liviana, y puede montarse al interior como al exterior.

El incremento o reducción del voltaje se logra usando a estos transformadores como autotransformadores y en estos casos solo el lado de bajo voltaje y de alta corriente maneja la carga. Debido a esto los transformadores pueden manejar varias veces su potencia nominal. Pueden venir con secundarios múltiples de 12/24, 24/48, o 16/32 Voltios. Dos o más transformadores pueden ser usados en varias combinaciones para obtener muchos otros voltajes especiales.

Ventajas

- Los eficientes materiales aislantes permiten que el tamaño sea compacto y liviano.
- Dobles voltajes primarios y secundarios para máxima versatilidad.
- El compartimiento de cableado amplio y de acceso frontal permite un cableado rápido y fácil.
- Las salidas pre troqueladas del compartimiento de conexión ubicadas a los lados, atrás y abajo son muy convenientes a la hora de la instalación.
- La herramienta de selección de autotransformadores de GE hace que esta tarea sea rápida y fácil.
- Muchos transformadores incrementadores – reductores de GE comparten las dimensiones de montaje con las de la competencia.
- Para servicio al interior como al exterior.

Características Principales

- El método más conveniente y menos costos para igualar el voltaje de línea con el voltaje del equipo.
- Más eficiente que los transformadores de aislamiento equivalentes.
- Capacidad de manejar cargas de hasta 20 veces su potencia de placa cuando se conectan como autotransformadores.
- Ideal para cambiar los voltajes de línea con pequeños valores.
- Los voltajes primarios pueden ser 120V, 240V y 480V.
- Los voltajes secundarios pueden ser 12V y 24V.
- Listados por UL y cUL.
- Calificados para los requerimientos sísmicos de IEEE-693-1997 e IBC-2003.



Transformadores Tipo QB, para uso interior/exterior; Monofásicos

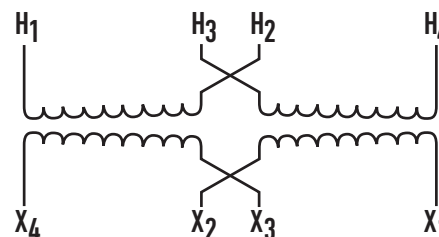

Aplicaciones

- Adaptación para voltajes internacionales.
- Circuitos de aire acondicionado comerciales e industriales.
- Sistemas de calefacción.
- Motores de inducción.
- Corrección de caídas de voltaje.
- Iluminación panorámica.
- Iluminación en bajo voltaje.



La operación eficiente de los equipos eléctricos requiere que el voltaje de línea sea lo más cercano al voltaje de placa del equipo. Con el fin de hacer coincidir la tensión de línea disponible (ya sea demasiado alta o baja) con la tensión del equipo.

No utilice los transformadores incrementadores – reductores para resolver un problema de tensión fluctuante. Sólo deben ser utilizados para compensar las condiciones de alta o baja tensión cuando el voltaje de línea disponible es razonablemente constante.

TRANSFORMADORES 1F (MONOFÁSICOS) | 120-240/12-24V | NEMA 3R ENCAPSULADOS

Imagen	Referencia	Potencia	Voltaje de entrada	Voltaje de salida	Medidas (Profundidad x Ancho x Alto)	Precio USD
	9T51B0111	1500VA (1.5KVA)	120-240	12-24	17,1x23,5x27,9 cm	1,055.08
	9T51B0112	2000VA (2KVA)	120-240	12-24	17,1x23,5x27,9 cm	1,077.26

TRANSFORMADORES 1F (MONOFÁSICOS) | 240-480/120-240V | NEMA 3R ENCAPSULADOS

Imagen	Referencia	Potencia	Voltaje de entrada	Voltaje de salida	Medidas (Profundidad x Ancho x Alto)	Precio USD
  	9T51B0002	50VA	240-480	120-240	7,9x12,7x15,6 cm	159.21
	9T51B0003	75VA	240-480	120-240	7,9x12,7x15,6 cm	175.73
	9T51B0004	100VA	240-480	120-240	7,9x12,7x15,6 cm	233.76
	9T51B0005	150VA	240-480	120-240	10,7x15,2x18,4 cm	284.86
	9T51B0007	250VA	240-480	120-240	10,7x15,2x18,4 cm	334.68
	9T51B0008	500VA	240-480	120-240	12,3x17,1x20,9 cm	400.85
	9T51B0009	750VA	240-480	120-240	13,9x19,7x24,1 cm	433.26
	9T51B0010	1000VA	240-480	120-240	13,9x19,7x24,1 cm	512.06
	9T51B0011	1500VA	240-480	120-240	17,1x23,5x27,9 cm	625.05
	9T51B0012	2000VA	240-480	120-240	17,1x23,5x27,9 cm	769.08
	9T51B0013	3000VA	240-480	120-240	17,1x23,5x27,9 cm	936.62
	9T21B1004G02	5000VA (5KVA)	240-480	120-240	27,9x26,7x36,5 cm	1,499.77
	9T21B1005G02	7500VA (7.5 KVA)	240-480	120-240	27,9x26,7x43,2 cm	2,254.29
9T21B1006G02	10000VA (10KVA)	240-480	120-240	31,6x31,4x43,2 cm	2,333.25	
9T21B9103	15000VA (15KVA)	240-480	120-240	31,6x31,4x43,2 cm	3,662.79	
9T21B9104	25000VA (25KVA)	240-480	120-240	40,5x42,2x52,9 cm	5,411.80	

TRANSFORMADORES DE PROPÓSITO GENERAL

Ventajas

- Operación silenciosa.
- Gabinete con diseño sin soldadura – el primero de la industria.
- Pruebas exhaustivas en fábrica aseguran la calidad.
- La instalación fácil y rápida ahorra tiempo.
- Documentación y etiquetado claro y conciso lo que incrementa la seguridad.

Características

- El diseño único del núcleo y del bobinado hacen del modelo QL uno de los transformadores más silenciosos del mercado.
- El conjunto núcleo y bobinado está montado sobre una base de caucho que aísla el ruido a la caja.
- Los terminales de los bobinados están empernados a las barras terminales lo que elimina los problemas de fallas en la soldadura y problemas asociados con sus salpicaduras.
- El frente o el espaldar pueden ser fácilmente removidos con propósito de mantenimiento.
- Los agujeros de montaje son muy accesibles desde el frente o fondo, sus agujeros alargados hacen muy simple el montaje.
- 100% probados en fábrica contra cortos, integridad del bobinado, corriente, pérdidas, voltaje, impedancia y ruido.
- Los gabinetes metálicos NEMA 2 a prueba de goteo son estándar, lo que se puede convertir a NEMA 3R con aleros adicionales, para uso exterior.
- Estos transformadores cumplen los requerimientos para áreas sísmicas según IEEE-693-1997 e IBC-2003.
- Bobinados en cobre o en aluminio.
- Platina de cobre para conexión a tierra.
- Empaque robusto con protecciones superior y lateral contra daños de manipulación y embarque.

Aplicaciones

- Comercial
- Industrial
- Motores
- Alumbrado Incandescente
- Calefacción por Resistencias
- Generadores (sin variadores electrónicos)



Control y Seguridad



Uso en baja tensión



Certificación TP1 Y DOE (USA)



97-98% de eficiencia

TRANSFORMADORES 3F (TRIFÁSICOS) DY | 480/ 127-220V

Imagen	Referencia	Potencia	Voltaje de entrada	Voltaje de salida	Medidas (Profundidad x Ancho x Alto)	Precio USD
	9T83B3381	15KVA	480	127-220V	42,9X47,5x69,3 cm	4,535.89
	9T83B3382	30KVA	480	127-220V	46,7X60,4x81,5 cm	5,467.45
	9T83B3383	45KVA	480	127-220V	46,7X60,4x81,7 cm	6,568.00
	9T83B3384	75KVA	480	127-220V	60,9X80,7x90,6 cm	8,371.60
	9T83B3385	112,5KVA	480	127-220V	60,9X80,7x101,3 cm	11,781.69
	9T83B3386	150KVA	480	127-220V	60,9X88,4x116,5 cm	13,805.80

TIPO DE CONEXIÓN

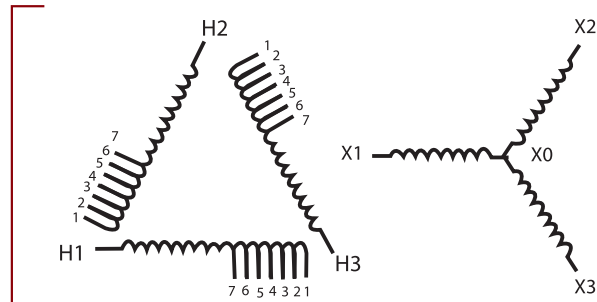

TRANSFORMADORES 3F (TRIFÁSICOS) DD | 480/240V | TP1 ALTA EFICIENCIA

Imagen	Referencia	Potencia	Voltaje de entrada	Voltaje de salida	Medidas (Profundidad x Ancho x Alto)	Precio USD
	9T83B3881	15KVA	480	220-380V	43X46x69 cm	4,415.64
	9T83B3882	30KVA	480	220-380V	47,5X58,5x82 cm	5,452.27
	9T83B3883	45KVA	480	220-380V	47,5X60x83 cm	5,729.05
	9T83B3884	75KVA	480	220-380V	62X80x91 cm	9,535.56
	9T83B3885	112,5KVA	480	220-380V	61X83x101 cm	11,653.65
	9T10A1196	150KVA	480	220-380V	101,6X130,81x73,66 cm	15,751.36

TIPO DE CONEXIÓN

